

Paving Accessories

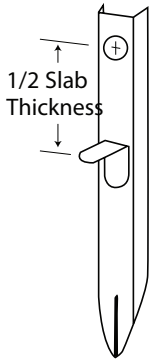

MS Stake

MS Stakes are available to hold dowel bars or tie bars in 6" — 11" thick slabs. They are fabricated in 16 and 18 gauge metal for 1/2", 5/8", and 3/4" bar diameters.

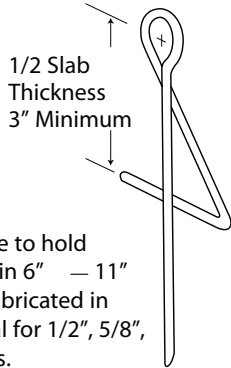

FS Stake

FS Stakes are available to hold dowel bars or tie bars in 6" — 11" thick slabs. They are fabricated in 5 gauge wire for 1/2" — 1-1/2" bar diameters.



Basket Stake

Welded hook type stakes are available to anchor dowel baskets. The stakes are fabricated in 6" — 21" lengths and .306" and 1/2" diameters.

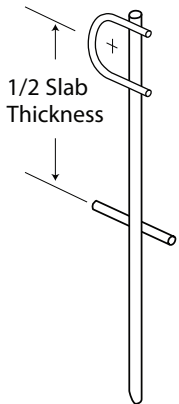

PS Stake

PS Stakes are available to hold dowel bars or tie bars in 6" — 18" thick slabs. They are fabricated in #1/0 gauge wire for 1/2", 5/8", 1", 1-1/4", and 1-1/2" bar diameters.

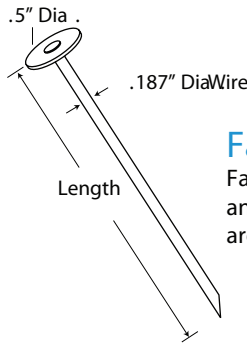

Fabric Stake

Fabric Stakes are available to anchor geotextile fabrics. They are fabricated in 18" lengths.



Channel Stake

Channel Stakes are available to support metal keyways in longitudinal and transverse joints of concrete slabs. They are fabricated in 14 and 16 gauge metal and 15" — 24" lengths.

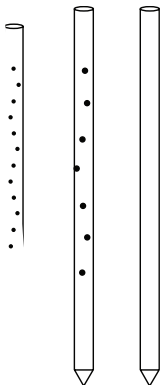

Round Stakes

Solid steel round stakes are available for use as stringline stakes, form pins, and nail stakes. They are fabricated from A36 Steel in 3/4", 7/8", and 1" diameters, and 12", 18", 24", 30", 36", 42", and 48" lengths. They are also available with nail holes, 6 per 12" stakes, and 9 per other lengths.

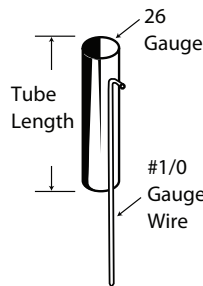

Mud Jack Tube

Mud jack tubes are available for bridge approach slabs from 12" — 16-1/2" thickness. The tube diameter is typically 2-1/2".

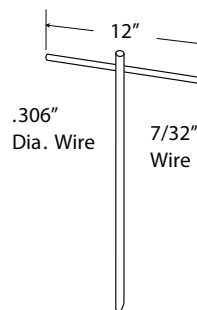

Mat Stake

Mat Stakes are fabricated in 9", 12", 18", and 24" lengths.

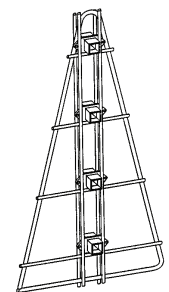

Barrier Dowel Aligner

Barrier dowel aligners are available to locate four one-inch dowels in a traffic barrier. Each requires four dowel aligners.

Paving Accessories



Dowel Caps

Metal and plastic dowel caps are available to allow movement of dowels in expansion joints. Crimp type metal dowel caps are fabricated in 5/8" — 1-1/4" diameters and 5" length. Welded type metal dowel caps are fabricated in 3/8" — 2" diameters and 5" and 6" lengths. Flanges on the welded type caps must be notched back when installing caps on dowels in baskets. Plastic dowel caps are fabricated in 1/2" — 1-7/8" diameters and 4" length.

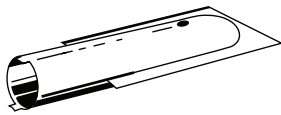

Crimp Type
I.D. = Nominal
Dia. + 1/16"

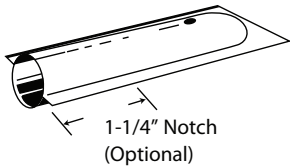

1-1/4" Notch
(Optional)

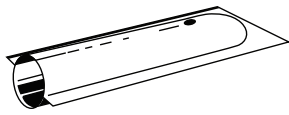

Welded Type
I.D. = Nominal Dia. + 1/8"

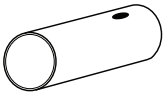

Plastic Caps
I.D. = Nominal Dia. + 1/32"

Longitudinal Joint Ties

Bolts and couplers are available as longitudinal joint ties in 5/8" and 3/4" diameters. Bolts are fabricated in hook or wiggle configurations.



Coupler

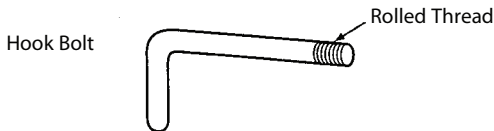

Hook Bolt

Rolled Thread



Wiggle Bolt

Rolled Thread

Basket Clips

Basket clips are available in wrap-around and nail-down styles to fasten baskets with nails in lieu of basket stakes.

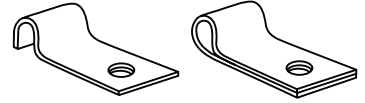

Dowel Tubes - Plastic

Plastic dowel tubes are used for the end-of-day pour applications, eliminating the need for drilling into the slab.

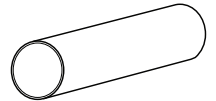

Dowel Bar Clips

Dowel bar clips are available for tying or clipping dowels to K-4 and K-5 baskets. They are fabricated for 3/4" — 1-5/8" diameter dowels.

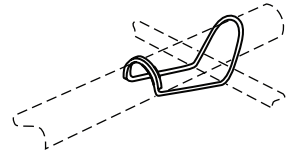

Grout Retention Ring

Grout retention rings are available for 5/8", 3/4", 1", 1-1/4", and 1-1/2" diameter dowels. They retain anchoring material and improve dowel support.

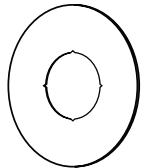

Snap-On Dowel Chair and Caps

Plastic dowel chairs are available for support of 1/2" through 1-1/2" diameter dowels used in retrofit applications. Contact DS Paving Products for pricing.

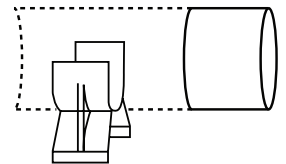

Dowel Aligner

Dowel aligners are available for alignment of 3/4" and 1" diameter dowels.

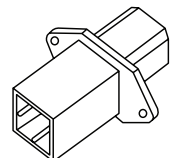

Paving Accessories



Metal Keyway - Center Strip

Metal keyways are available to form keyways along longitudinal and transverse joints in concrete slabs. The false form, K-30, is fabricated in 16 and 18 gauge metal for 7-1/2" to 12" slabs.

The general center strip, K-33, is fabricated in 18 and 20 gauge metal for 4-1/2" to 10" slabs.

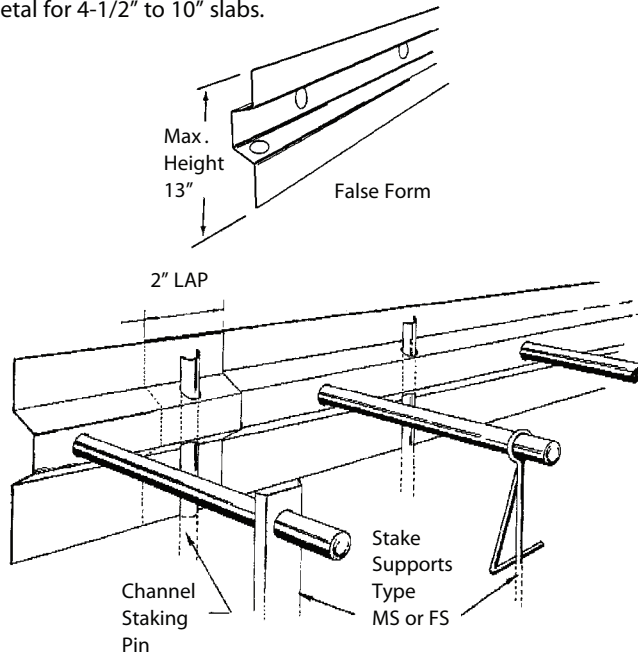

Metal Keyway - Recess Form

Recess form keyways are available for longitudinal joints in 6" to 10" thick concrete slabs. They are fabricated in standard key way deformation, K-34, or half-round deformation, K-35, in 24, 18, or 16 gauge metal.

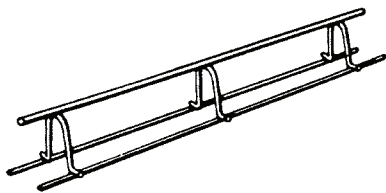
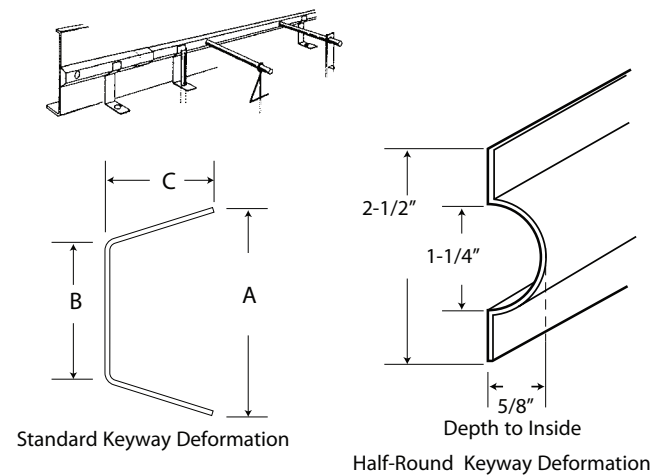

Continuous Mesh Support

Continuous mesh supports are manufactured in 5' 0" lengths and 3", 4", 5", 6", and 7" heights.

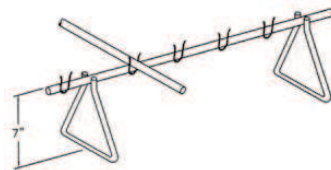

Transverse Bar Assembly (TBA)

Eliminates wire tying to longitudinal bar for CRCP replacement. Transverse reinforcement hooks directly to longitudinal bar. Snaps quickly to track. Saves labor, as a six person crew can typically lay one lane mile per 8 hour shift. Accurate position of clips creates uniform separation for continuous bar placement. Custom manufactured to specs in both uncoated or epoxy coated.

Continuous High Chair Upper (CHCU)

These continuous supports are available in 2" through 25" heights. They are fabricated in Bright Basic Wire (CHCU-3) or Epoxy-coated wire. Per 100 Ft. or per 100 pcs.

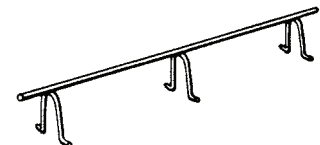

Continuous High Chair (CHC)

Continuous high chairs provide reinforcing steel support from 2" to 20" heights. They are available in Bright Basic Wire (CHC-3), Galvanized Wire (CHC-GW), Stainless Steel, Plastic Protected Legs (CHC-1), and Epoxy-coated Wire, 2" through 20" high. Per 100 Ft. or Per 100 Pcs.